

BC-4000



BC-4000S



BC-4000L1

**More accurate
and faster.**



BC-4000E



BC-4000L2

BC-4000 series features versatile functions, applicable to various wholesalers and supermarkets.

HIGH PRECISION

High precision weighing

High precision weighing is welcomed by every customer.

Minimum graduation is 1g.(For 3/6kg capacity type)

Maximum weighing capacity is 15kg.(For 6kg/15kg capacity type)

Smooth and wide platter surface.

MEMORY EXPANSION

High capacity memory

Large enough to store the transaction data and product master data.

Memory capacity can be expanded to maximum **4 MB.**
(Standard : 2 MB)

HIGH QUALITY DISPLAY

High quality display

Bright display with distinct visual effects.

Displayed message can be viewed even from an oblique direction.

Clear figure display.

HISPEED PRINTING

High quality label printing

Fast, brisk, visible label printing.

- * Fast, brisk, visible label printing
- * Reliable thermal print head with high technology.

Various barcodes,ITF,UPC and EAN,can be printed.

Free to create label printing formats.

Able to create various POP indications for commercial promotion.

Able to create various POP indications for commercial promotion.(Having applied patent ZL200430084273.6)



Big, visible fonts.



EASY OPERATION

Easy operate

Simple and convenient operation to call up and program product master data.

Light touch on the numeric keys.

170 preset keys.

Various preset functions and PLU can be assigned to normal operation keysheet.



Separate key sheet for normal operation.



Numeric keys are click key type.

SYSTEM INTEGRATION

BC-4000 series processes transaction data statistically for the store management.

Product master data is totally controlled on computer and transferred to each satellite scale printer.



PC Server to control data to/from satellite scale printer.



Data transmission to satellite scale printer used at each department.

BC-4000L2

Liquid crystal display.
Displays commodity name.
Advertisement display compatible.

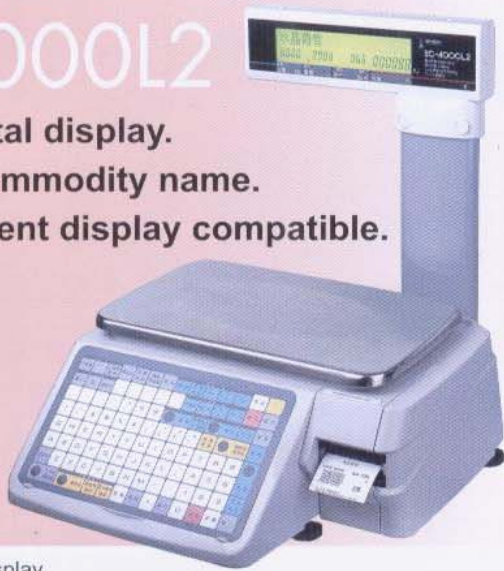

Commodity name display.



Advertising display.



* Scrolling display, Flashing display.

BC-4000L1

Liquid crystal display.
Displays commodity name.

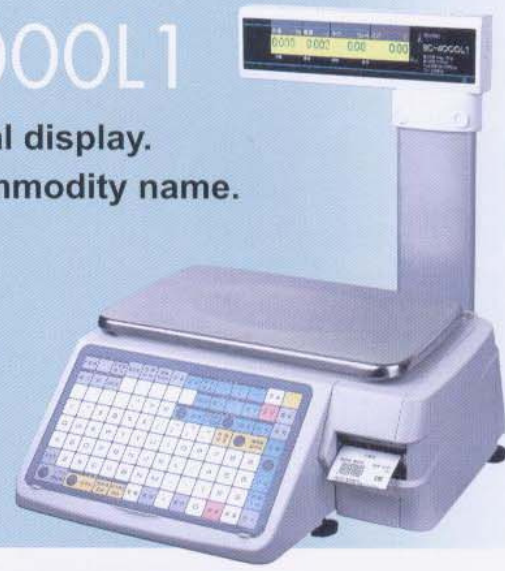

Normal display.



Commodity name display.



* Instant display.

BC-4000S

High-brightness fluorescent display. (color: green)

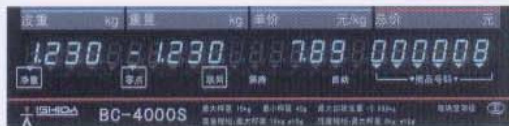
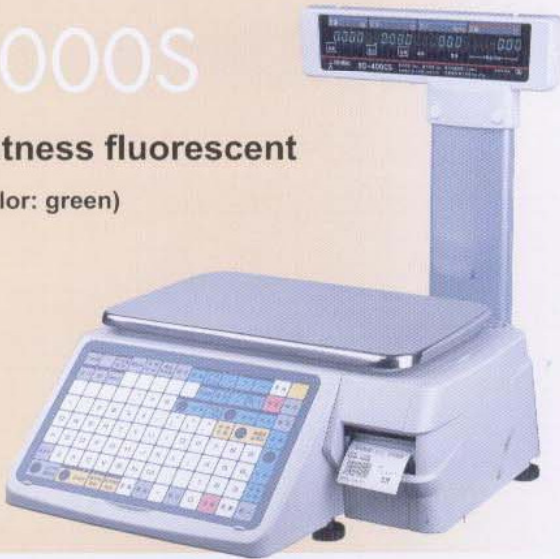

BC-4000E

LED display. (color: red)
Total amount display in Capital.

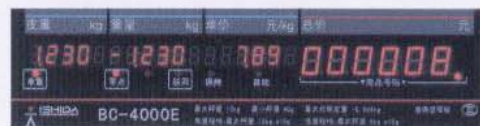
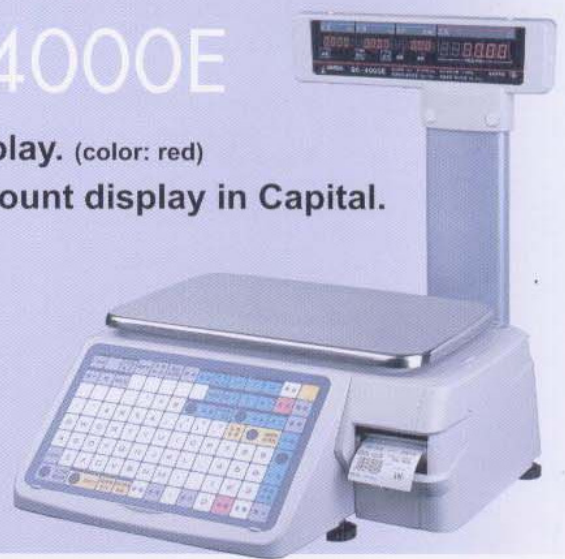

SLP-V(Versatile)

Software is designed to operate in Windows 2000 and Windows XP .
Scale Link Pro-V is powerful Windows-based program that integrate new or existing computer networks using a PC server or a multi-store centralized host.The point-and-click menus mean you are able to make price changes immediately or create sale batches,centrally or in store.Distribution can be immediate or scheduled to all scales.
You can create reports showing production totals by operator,hourly,daily,or weekly.With Scale Link Pro-V you will be assured that what is comming in the back door is getting to the scale,and into the register.
Integration with other useful software tools,i-Lable and i-View,are available.

(The following data could be downloaded by PC at any time.)
Master data of new product,Product alteration,Price alteration.Store name/address,Keyboard arrangement,Date/time,Scroll advertisement (BC-4000L2).



Superior performance in shape, features with affordable price

The brand-new BC-4000 series has the highest cost performance.

Simple programming tool

Using simple special software, you can quickly edit PLU on a PC and communicate via TCP/IP.

Fast printing

Printing speed is 80mm per second.

Various multiple-functional keys

Frequently used PLUs can be assigned to preset keys for quick operation. Various discount function keys (Discount price, \$, -, %), Peeling timer key to set a delay time between labels, Save key to keep called PLU, Batch No. key, etc.

Internal memory extendable to maximum 4MB

Specifications

Model Name	BC-4000 series
keyboard	170 preset keys + 10 numeric keys
Capacity	6/15kg(3/6kg)
Max. weighing capacity	15kg(6kg)
Min. weighing capacity	40g(20g)
Min. graduation	2/5g(1/2g)
Accuracy	1/3000
Communications	TCP/IP
Display	Tare 4 digits, weight 5 digits, unit price 5 digits, total price 6 digits
Printing speed	80mm/sec.
Power supply	AC 220V/240V, 50/60Hz
Power consumption	50W (stand-by) / 100W (in operation)
Operating temperature	-10°C to +40°C
Operating humidity	15%RH to 85%RH

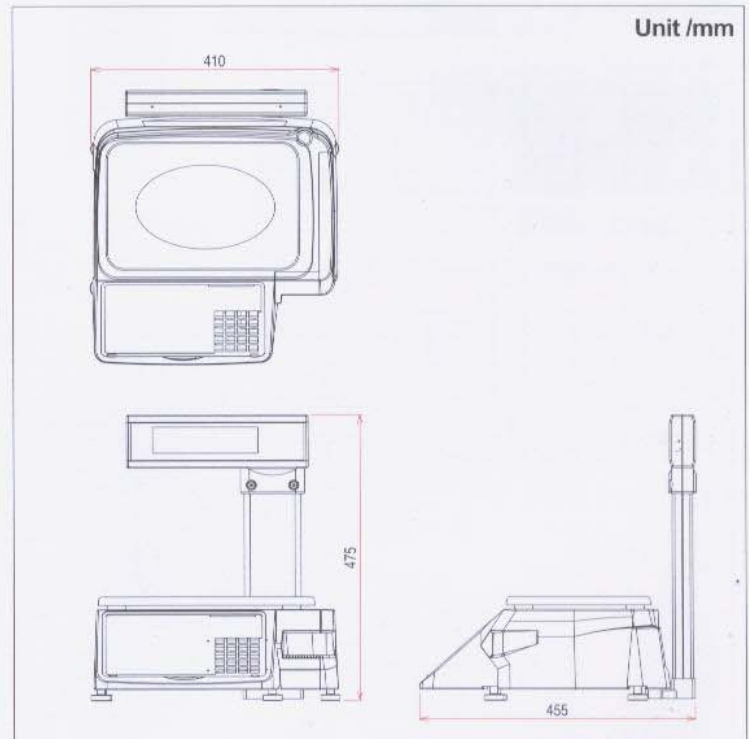

 **ISHIDA**

 **ISHIDA CO., LTD.**

Address: 44, SANNO-CHO, SHOGOIN, SAKYO-KU,
KYOTO 606-8392 JAPAN
Tel : 81-75-771-4141
Facsimile : 81-75-751-1634
URL: <http://www.ishidajapan.com>

Design and specifications are subject to change without notice